

DATA SHEET

Community L SERIES Beamforming Venue Horn™



LVH-906/AP

60° HORIZONTAL DISPERSION,
ACTIVE PLUS, 20°, 80°, 100° VERTICAL DISPERSION,
ARRAYABLE, HIGH OUTPUT LOUDSPEAKER

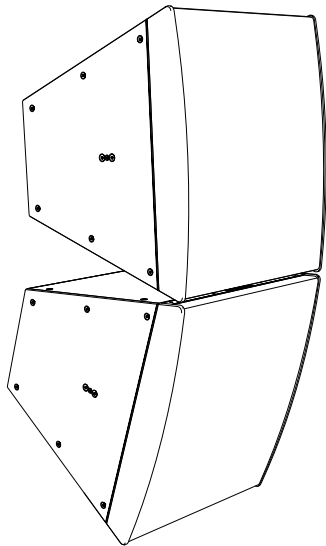

FEATURES

- Designed with individual driver control for extraordinary performance in large venues
- Large format, horn-loaded triaxial array maintains pattern control to 200Hz
- Maximize long-throw SPL level or extend vertical coverage pattern
- Colinear manifold for HF and MF beamforming
- Indoor or Outdoor weather-resistant models

APPLICATIONS

Stadiums · Houses of Worship · Arenas
Theaters · Ice Rinks · Auditoriums
Large Multipurpose Outdoor and Indoor Venues

DESCRIPTION

Biamp's Community L SERIES LVH-900/AP Beamforming Venue Horn, combined with the Community Amplified Loudspeaker Controllers (ALCs), precisely tailors the directivity of each loudspeaker, or array of loudspeakers, to meet the sound requirements in any application.

Designed for exceptional performance in large venues, each 60° Active Plus array consists of two LVH-906/AP loudspeakers with a total of eight 12-inch LF drivers, six Community M200 midrange compression drivers and eight 1.5-inch HF compression drivers.

Using patent pending techniques, the triaxial drivers in each cabinet are integrated to create half of the desired vertical coverage pattern. Using advanced FIR techniques, the output from the two loudspeakers are seamlessly integrated into one coherent wavefront filling the entire 72 x 31-inch face of the array, providing pattern control to below 200Hz. An LVH-906/AP array offers 60 degrees of fixed horizontal dispersion, three presets for vertical dispersion beamforming and has specialized input panels for dual cabinet long-throw configurations. The LVH-900 Active-Plus (AP) models allow DSP settings and control of individual drivers to provide uniform sound to the audience areas.

Typical applications include music and speech reinforcement for large houses of worship, stadiums, theatres, and much more. Possessing advanced features, highly-focused dispersion patterns, weather-resistant construction, and most importantly sonic excellence, LVH-900 loudspeakers make installations not only fast and simple, but as functionally effective as possible.

TECHNICAL SPECIFICATIONS¹

Operating Mode	Multi-Amplifier with FIR DSP Beamforming		
Operating Environment	Indoor or Outdoor Direct Exposure		
Operating Range (-10dB) ²	60 Hz to 18 kHz		
Nominal Beamwidth	Horizontal: 60° Vertical: Dual Cabinet 20°, 80°, 100° Patterns (FIR DSP user selectable preset)		
Transducers (Each Cabinet)	LF - 4 x 12" (305mm) with 3" (76mm) CCAW voice coil, inherently weather-resistant cone in cast aluminum chassis MF - 3 x M200, 2" (51mm) exit, ketone polymer diaphragm, compression driver HF - 4 x 1.5" (38mm) CCAW voice coil, 1" (25mm) exit, ketone polymer diaphragm, compact neodymium compression driver		
Continuous Signal Voltage @ Nominal Impedance ³	LF1, LF2, LF3, LF4 (each)	89V, 8 ohms (178V peak)	
	MF 1, MF2, MF3 (each)	26V, 5 ohms (52V peak)	
	HF 1, HF2, HF3, HF4 (each)	23V, 8 ohms (46V peak)	
Crossover Frequencies	550 Hz, 2.5kHz		
Equalized Maximum SPL @ 1m ⁴	Dual 20° Pattern	Peak 146 dB	Continuous 140 dB
	Dual 80° Pattern	143 dB	137 dB
	Dual 100° Pattern	143 dB	137 dB
Recommended Amplifiers for a Dual Cabinet Pattern	DSP with Linear Phase FIR processing included in all Community Amplified Loudspeaker Controllers (ALC models)		
	LF1, LF2 (2 Ch.) x2	(2) ALC-1604D (Bridged)	
	All MF & HF (6 Ch.)	(2) ALC-404D	

PHYSICAL

Input Connection	Lever-actuated wire clamping 4, 6 and 8-position terminal blocks
Mounting Points	(24) M10 rigging inserts per cabinet
Operation Environment	Indoor and Outdoor Outdoor: IP56 per IEC 60529 when used with the input panel and seal cup cover plates; Weather resistant to IEC 60068-2-1 Cold, IEC 60068-2-2 Dry Heat, IEC 60068-2-6 Vibration, IEC 60068-2-30 Damp Heat, cyclic, IEC 60068-2-42 SO2, and IEC 60068-2-78 Damp Heat, steady state
Dimensions H x W x D	37.3" x 31.4" x 30.5" (948 x 797 x 775 mm)
Weight (each cabinet)	250 lbs (113.4 kg) Indoor model 210 lbs (95.3 kg) Outdoor weather-resistant model
Finish	Refer to the Technical Drawing (page 5)

OPTIONS

Accessories (full list on page 6)	Splay Bracket: LVH-900SP1 Type 1; LVH-900SP2 Type 2 Indoor Frames: LVH-900AF Array frame; LVH-900PB Pull-back 3rd party rigging: Indoor & outdoor
-----------------------------------	--

Biamp strives to improve its products on a continual basis. Specifications are therefore subject to change without notice.



A: 9300 S.W. Gemini Drive Beaverton, OR 97008 USA

T: +1 503.641.7287

W: www.biamp.com

Community L SERIES Beamforming Venue Horn

LVH-906/AP

60° HORIZONTAL DISPERSION,
ACTIVE PLUS, 20°, 80°, 100° VERTICAL DISPERSION,
ARRAYABLE, HIGH OUTPUT LOUDSPEAKER

20° DUAL-CAB PATTERN

AXIAL PROCESSED SENSITIVITY (dB)⁵

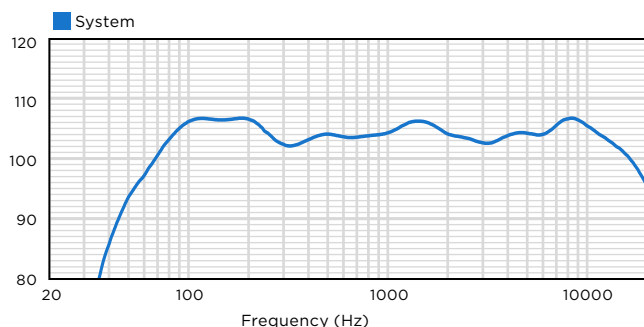

HORIZONTAL OFF-AXIS RESPONSE (dB)⁶

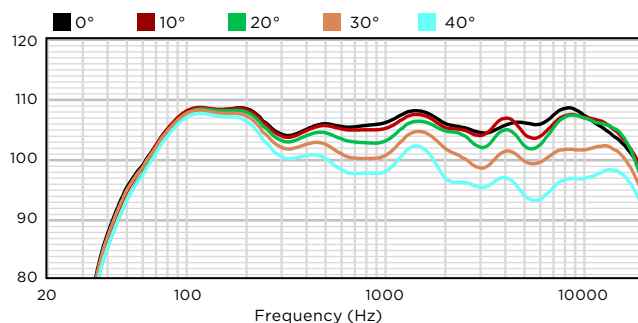

IMPEDANCE (Ohms)

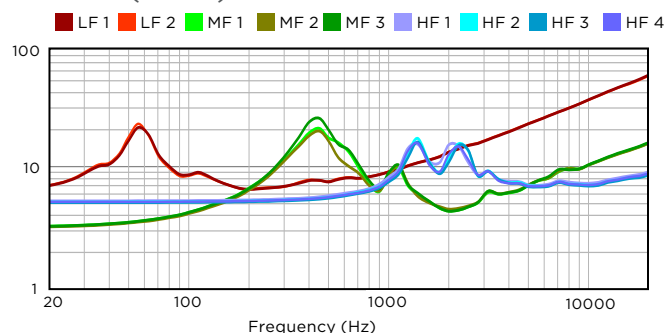

Min Impedance: (LF1) 6.5 Ω @ 200Hz, (LF2) 6.5 Ω @ 200Hz
(MF 1) 4.5 Ω @ 2 kHz, (MF 2) 4.5 Ω @ 2 kHz, (MF 3) 4.5 Ω @ 2 kHz,
(HF 1) 7.0 Ω @ 5.6 kHz, (HF 2) 6.9 Ω @ 5.6 kHz, (HF 3) 6.8 Ω @ 5.6 kHz, (HF 4) 6.9 Ω @ 5.6 kHz

VERTICAL OFF-AXIS RESPONSE (dB)⁶

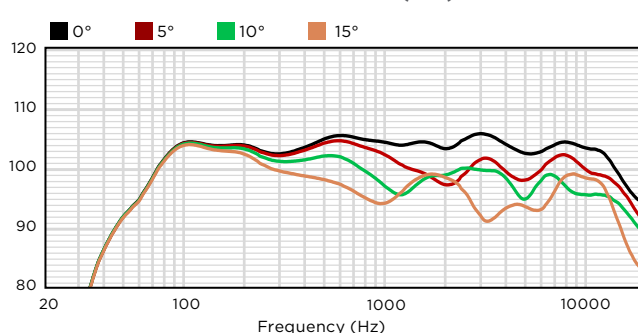

DIRECTIVITY INDEX (dB)⁷

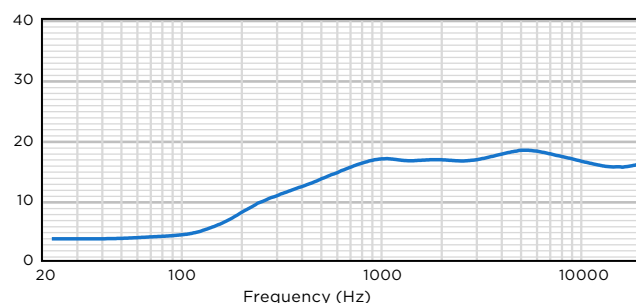

BEAMWIDTH (Degrees)⁸

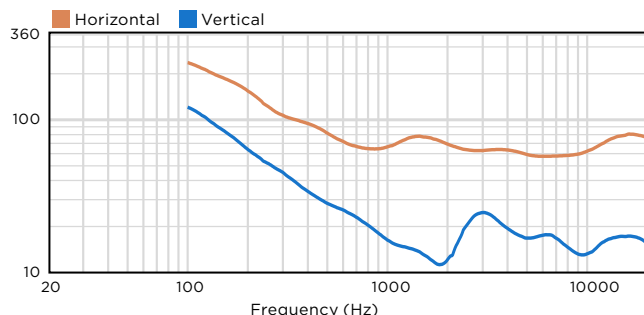

Community L SERIES Beamforming Venue Horn

LVH-906/AP

60° HORIZONTAL DISPERSION,
ACTIVE PLUS, 20°, 80°, 100° VERTICAL DISPERSION,
ARRAYABLE, HIGH OUTPUT LOUDSPEAKER

80° DUAL-CAB PATTERN

AXIAL PROCESSED SENSITIVITY (dB)⁵

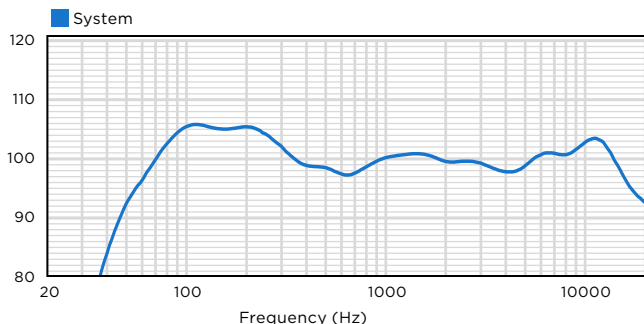

HORIZONTAL OFF-AXIS RESPONSE (dB)⁶

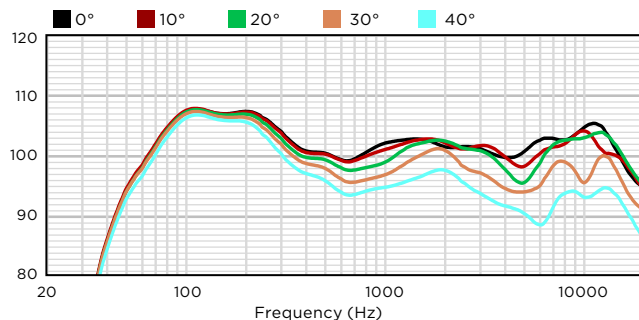

IMPEDANCE (Ohms)

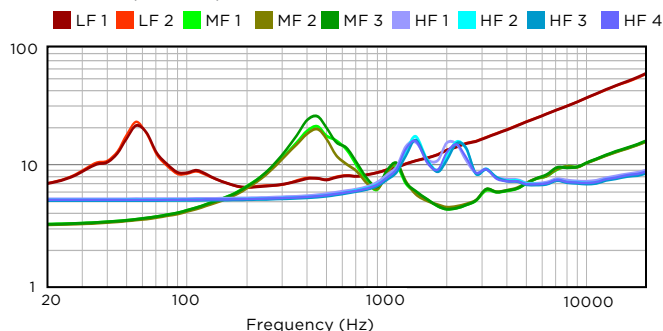

Min Impedance: (LF1) 6.5 Ω @ 200Hz, (LF2) 6.5 Ω @ 200Hz
(MF 1) 4.5 Ω @ 2 kHz, (MF 2) 4.5 Ω @ 2 kHz, (MF 3) 4.5 Ω @ 2 kHz,
(HF 1) 7.0 Ω @ 5.6 kHz, (HF 2) 6.9 Ω @ 5.6 kHz, (HF 3) 6.8 Ω @ 5.6 kHz, (HF 4) 6.9 Ω @ 5.6 kHz

VERTICAL OFF-AXIS RESPONSE (dB)⁶

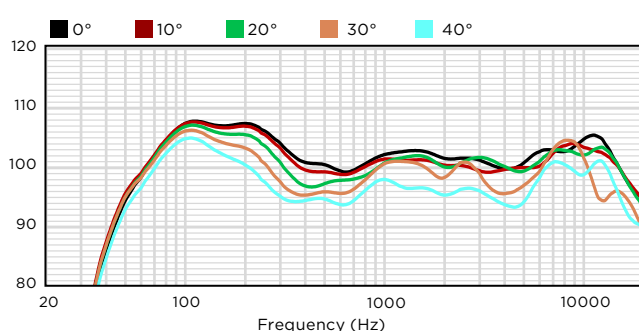

DIRECTIVITY INDEX (dB)⁷

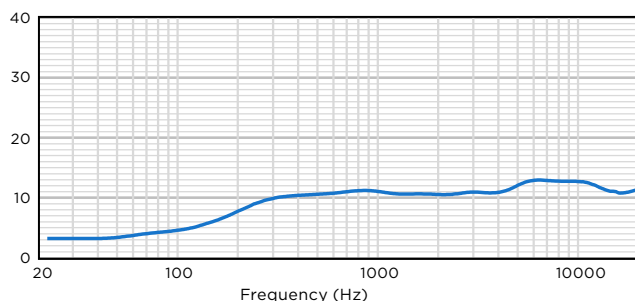

BEAMWIDTH (Degrees)⁸

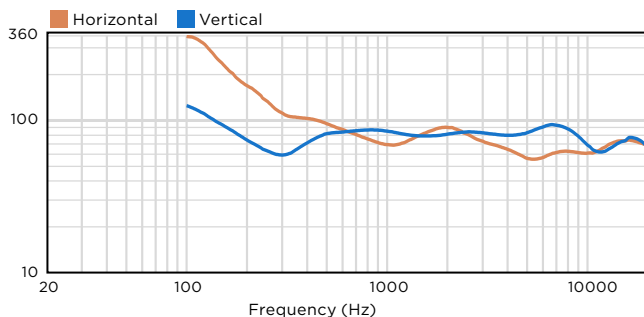

Community L SERIES Beamforming Venue Horn

LVH-906/AP

60° HORIZONTAL DISPERSION,
ACTIVE PLUS, 20°, 80°, 100° VERTICAL DISPERSION,
ARRAYABLE, HIGH OUTPUT LOUDSPEAKER **100° DUAL-CAB PATTERN**

AXIAL PROCESSED SENSITIVITY (dB)⁵

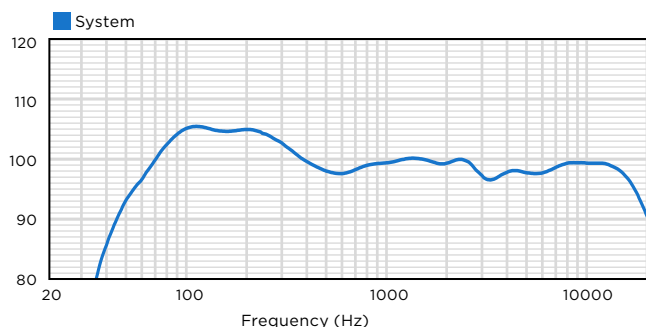

HORIZONTAL OFF-AXIS RESPONSE (dB)⁶

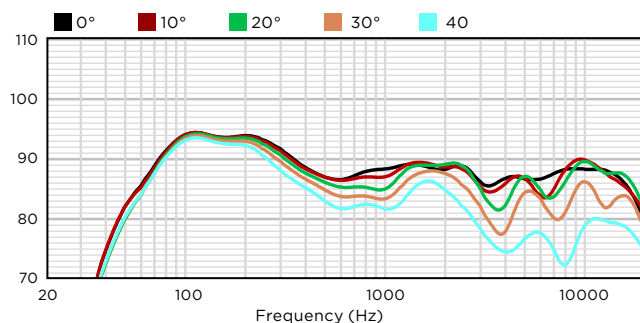

IMPEDANCE (Ohms)

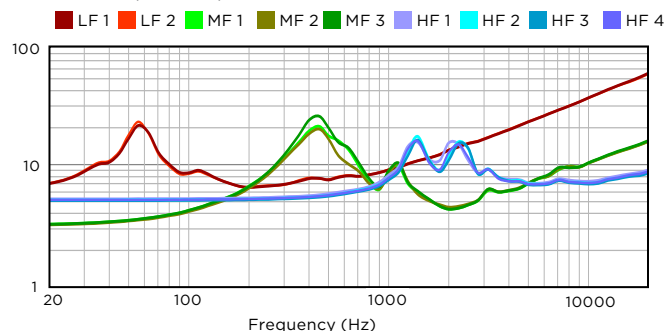

Min Impedance: (LF1) 6.5 Ω @ 200Hz, (LF2) 6.5 Ω @ 200Hz
(MF 1) 4.5 Ω @ 2 kHz, (MF 2) 4.5 Ω @ 2 kHz, (MF 3) 4.5 Ω @ 2 kHz,
(HF 1) 7.0 Ω @ 5.6 kHz, (HF 2) 6.9 Ω @ 5.6 kHz, (HF 3) 6.8 Ω @ 5.6 kHz, (HF 4) 6.9 Ω @ 5.6 kHz

VERTICAL OFF-AXIS RESPONSE (dB)⁶

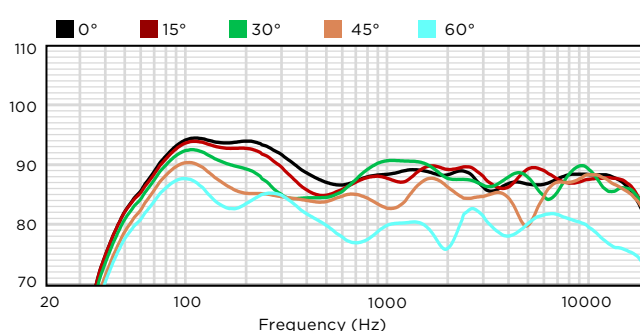

DIRECTIVITY INDEX (dB)⁷

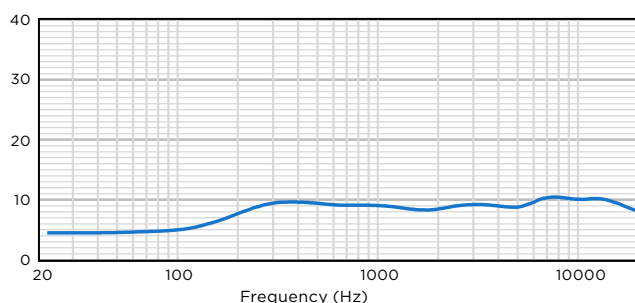

BEAMWIDTH (Degrees)⁸

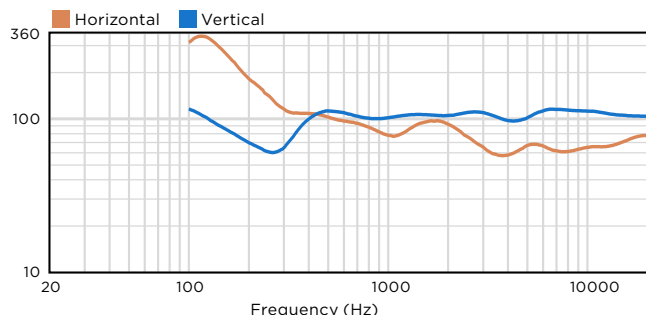

Community L SERIES Beamforming Venue Horn

LVH-906/AP

60° HORIZONTAL DISPERSION,
ACTIVE PLUS, 20°, 80°, 100° VERTICAL DISPERSION,
ARRAYABLE, HIGH OUTPUT LOUDSPEAKER

TECHNICAL DRAWING / DIMENSIONS / FINISH

H x W x D

37.3" x 31.4" x 30.5"
(948 x 797 x 775 mm)

Unit Weight

250 lbs (113.4 kg) (Indoor)

210 lbs (95.3 kg) (Outdoor Weather-resistant)

Shipping Weight (on a pallet)

307 lbs (139.3 kg) (Indoor)

267 lbs (121 kg) (Outdoor Weather-resistant)

Enclosure Finish

Indoor: Powder-coated perforated steel (indoor) grille backed with acoustically transparent woven fabric and coated with Biamp's robust PolyCoat finish on 15mm Baltic Birch plywood enclosure

Outdoor (WR): Powder-coated marine grade aluminum grille featuring hydrophobically-treated acoustically transparent woven black fabric backing on a 15mm PolyGlas™ enclosure coated with Biamp's durable PolyCoat finish, rated for both indoor and outdoor use

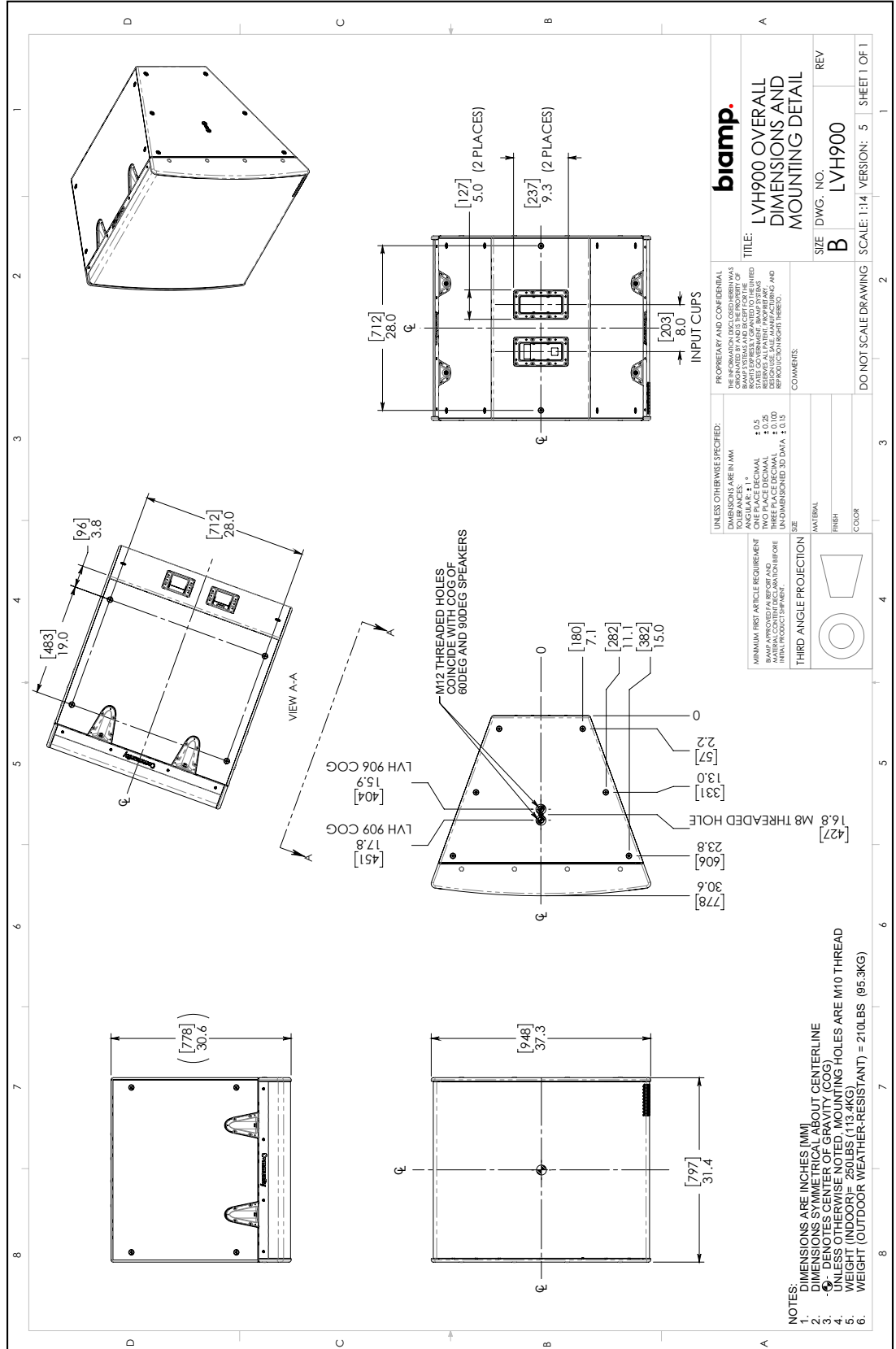

Community L SERIES Beamforming Venue Horn

LVH-906/AP

60° HORIZONTAL DISPERSION,
ACTIVE PLUS, 20°, 80°, 100° VERTICAL DISPERSION,
ARRAYABLE, HIGH OUTPUT LOUDSPEAKER

SPLAY BRACKETS / DUAL CABINET CONFIGURATIONS

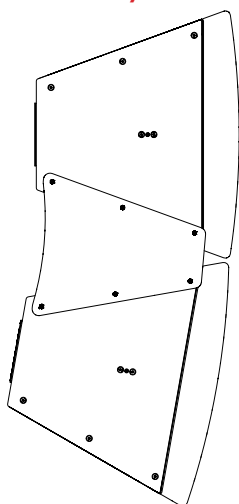

Achieves the 20° pattern

Type 2 Splay Bracket

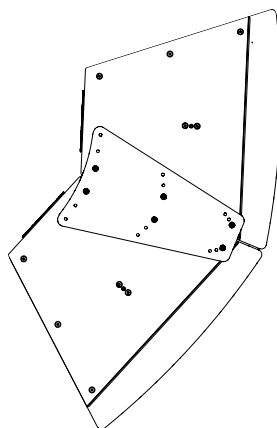

Achieves the 80° pattern

Type 1 Splay Bracket

0° hole set - Back Splay

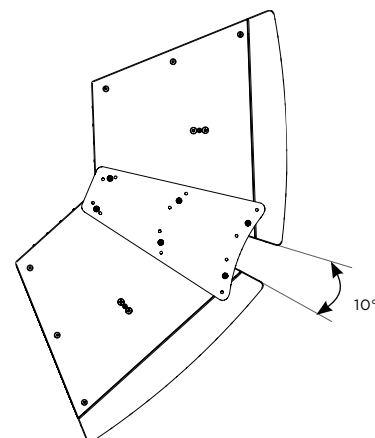

Achieves the 100° pattern

Type 1 Splay Bracket

10° hole set - Front Splay

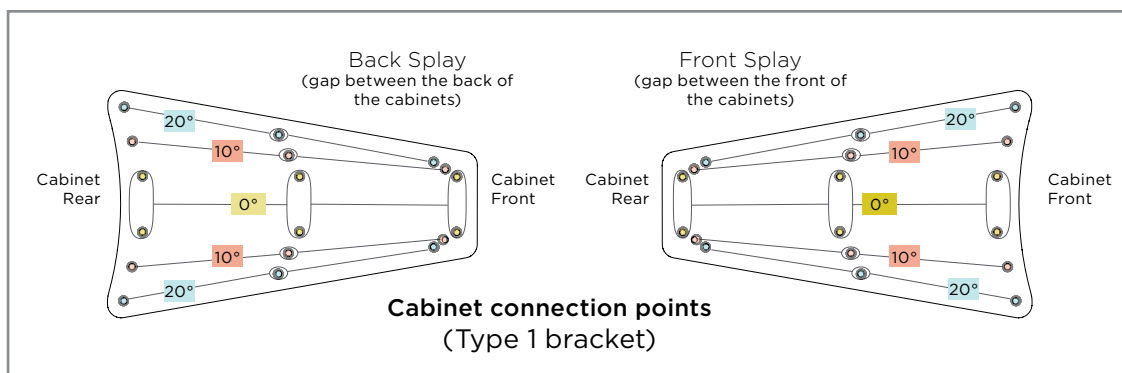

MODELS and ACCESSORIES

Models	Description
LVH-906/APB	LVH-900 60DEG ACTIVE-STD BLK
LVH-906/APW	LVH-900 60DEG ACTIVE-STD WHT
LVH-906WR/APG	LVH-900WR 60DEG ACTIVE-STD GRY
LVH-906WR/APB	LVH-900WR 60DEG ACTIVE-STD BLK
LVH-906WR/APW	LVH-900WR 60DEG ACTIVE-STD WHT
LVH-906C/AP	LVH-900 60DEG ACTIVE-STD CTO
LVH-906WRC/AP	LVH-900WR 60DEG ACTIVE-STD CTO
LVH-909/APB	LVH-900 90DEG ACTIVE-STD BLK
LVH-909/APW	LVH-900 90DEG ACTIVE-STD WHT
LVH-909WR/APG	LVH-900WR 90DEG ACTIVE-STD GRY
LVH-909WR/APB	LVH-900WR 90DEG ACTIVE-STD BLK
LVH-909WR/APW	LVH-900WR 90DEG ACTIVE-STD WHT
LVH-909C/AP	LVH-900 90DEG ACTIVE-STD CTO
LVH-909WRC/AP	LVH-900WR 90DEG ACTIVE-STD CTO

Accessories	Description
LVH-900AFB	LVH-900 ARRAY FRAME BLK
LVH-900AFW	LVH-900 ARRAY FRAME WHT
LVH-900PBB	LVH-900 PULL BACK BAR BLK
LVH-900PBW	LVH-900 PULL BACK BAR WHT
LVH-900SP1B	LVH SPLAY PLATE PAIR TYPE1 BLK
LVH-900SP1W	LVH SPLAY PLATE PAIR TYPE1 WHT
LVH-900SP1G	LVH SPLAY PLATE PAIR TYPE1 GRY
LVH-900SP2B	LVH SPLAY PLATE PAIR TYPE2 BLK
LVH-900SP2W	LVH SPLAY PLATE PAIR TYPE2 WHT
LVH-900SP2G	LVH SPLAY PLATE PAIR TYPE2 GRY

Community L SERIES Beamforming Venue Horn

LVH-906/AP

60° HORIZONTAL DISPERSION,
ACTIVE PLUS, 20°, 80°, 100° VERTICAL DISPERSION,
ARRAYABLE, HIGH OUTPUT LOUDSPEAKER

CONNECTION DIAGRAM

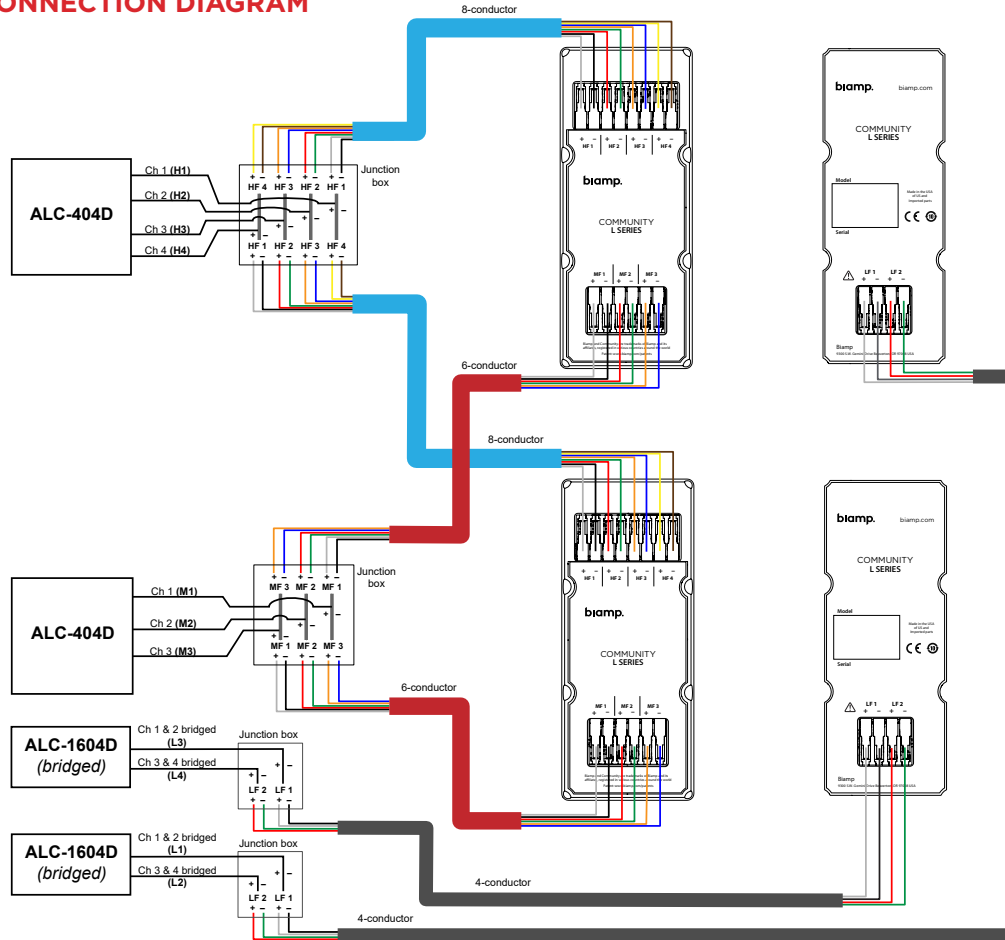

Dual LVH-900/AP with
(2) ALC-404D & (2) ALC-1604D
(1 channels necessary)

NOTES

- PERFORMANCE SPECIFICATIONS** All measurements are taken indoors using a time-windowed and processed signal to eliminate room effects, approximating an anechoic environment, a distance of 6.0 m. All acoustic specifications are rounded to the nearest whole number. An external DSP using settings provided by Biamp is required to achieve the specified performance; further performance gains can be realized using the FIR loudspeaker optimization presets available in Biamp's Community Amplified Loudspeaker Controllers (ALC SERIES).
- OPERATING RANGE** The frequency range in which the on-axis processed response remains within 10dB of the average SPL.
- CONTINUOUS POWER HANDLING** Maximum continuous input voltage at the stated nominal impedance that the system can withstand, without damage, for a period of 2 hours using an EIA-426-B defined spectrum; with recommended signal processing and protection filters.
- EQUALIZED MAXIMUM SPL** The SPL produced when an EIA-426-B signal is applied to the equalized loudspeaker system, at a level which drives at least one subsection to its rated continuous input voltage limit, referenced to a distance of 1 meter. The peak SPL represents the 2:1 (6dB) crest factor of the EIA-426-B test signal.
- AXIAL PROCESSED SENSITIVITY** The on-axis variation in acoustic output level with frequency for a 1 Watt swept sine wave, referenced to 1 meter with recommended signal processing applied.
- HORIZONTAL / VERTICAL OFF-AXIS RESPONSES** The loudspeaker's magnitude response at various angles off-axis, with recommended signal processing applied in the operating mode which utilizes the largest number of individually amplified pass bands.
- DIRECTIVITY INDEX** The ratio of the on-axis SPL squared to the mean squared SPL at the same distance for all points within the measurement sphere for each given frequency; expressed in dB.
- BEAMWIDTH** The angle between the -6dB points in the polar response of the loudspeaker when driven in the operating mode which utilizes the largest number of individually amplified pass bands.

Data presented on this spec sheet represents a selection of the basic performance specifications for the model. These specifications are intended to allow the user to perform a fair, straightforward evaluation and comparison with other loudspeaker spec sheets. For a detailed analysis of this loudspeaker's performance, please download the GLL file and/or the CLF file from our website: [\(LVH-900/AP data here\)](#)

CAUTION: Installation of loudspeakers should only be performed by trained and qualified personnel. It is strongly recommended that a licensed and certified professional structural engineer approve the mounting design.



A: 9300 S.W. Gemini Drive Beaverton, OR 97008 USA

T: +1 503.641.7287

W: www.biamp.com